

AOSONG

Digital temperature

DHT12 Product

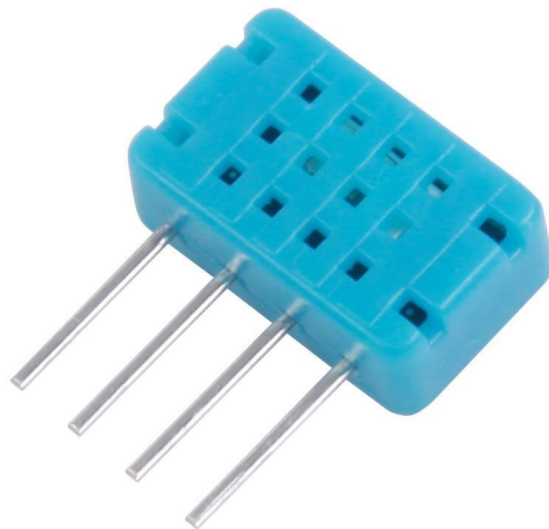

Product

- Ultra small
- 超Low
- Ultra low
- Excellent long term
- Stan I²C And the single-

For more information, www.aosong.com

A product overview

DHT12 Digital temperature and humidity sensor is a calibrated digital output record of temperature and humidity, DHT11 The upgrade product. Application-specific digital temperature and humidity sensor module and semiconductor, ensure high reliability and excellent long-term stability.

DHT12 With a single bus, and standards I²C Two kinds of communication and single bus communication mode is fully compatible with DHT11. Standard bus interface makes it simple and quick to system integration. With super small size, low power consumption, suitable for a wide variety of applications. I²C Communication uses standard communication sequence, the user can directly I²C Communication on the bus, no additional wiring, simple to use. Two way switch, users are free to choose, easy to use, should be a broad range of areas. Products for the 4 Lead, convenient connection, provides special packages according to user needs.

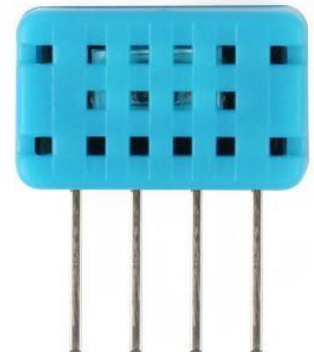

Second, the scope of application

Heating, ventilation and air conditioning , Dehumidifier, test and inspection equipment, consumer products, automotive, automation, data recorders, weather stations, home appliances, control, Medical and other relative humidity control.

Third, product highlights

Fully interchangeable, low cost, long term stability, relative humidity and temperature measurement, signal transmission of long distance, digital output, precise calibration, power consumption is very low, the standard single-wire digital interface, the standard I²C Bus digital interface, communication can be freely chosen.

Four, dimensions (unit:mm)



图 1DHT12 Profile of best-inch

External interface:1:VDD 2:SDA 3: GND 4:SCL

Five, sensor performance

5.1 Relative humidity

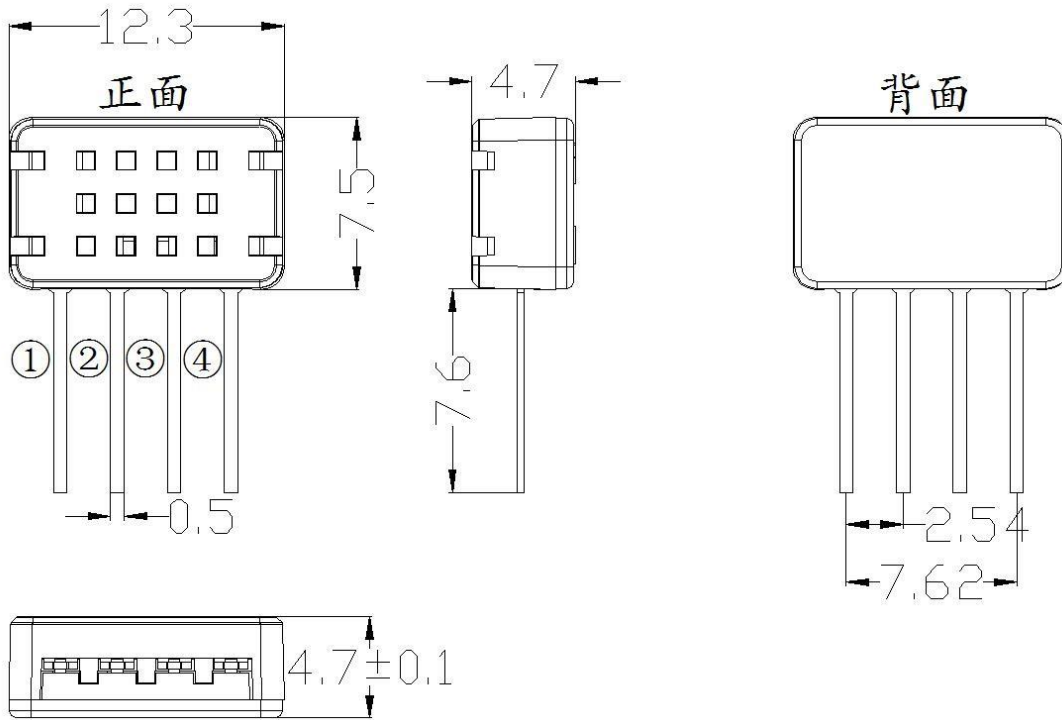
5.2 Temperature

表 1 : DHT12 Relative humidity tables

表 2 : DHT12 Relative performance table

Parameters	Conditions	min	typ	max	Work unit
Resolution			0.1		%RH
Measuring range		20		95	%RH
Precision ¹	60%RH		±5		%RH

Parameters	Conditions	min	typ	max	Work unit
Resolution			0.1		°C
			16		bit
Precision	25 °C		±0.5		°C

¹ 此精度为出厂时检验时，传感器在 25°C和 5V，条件下测试的精度指标，且只适合非冷凝环境。

参数	条件	min	typ	max	单位
----	----	-----	-----	-----	----

Repeatability		± 0.3		%RH
Interchangeability	Fully interchangeable			
Response time ¹	1/e(63%)	<20		S
Hysteresis		± 0.5		%RH
Drift ²³	Typical value	<0.5		%RH/yr

Measuring range		-20		60	°C
Repeatability			± 0.2		°C
Interchangeability	Fully interchangeable				
Response time	1/e(63%)		<20		S
Drift			± 0.1		°C/yr

供电电压		2.7	5	5.5	V
功耗 ⁴	休眠		30		μA
	测量		800		μA
	平均		150		μA
低电平输出电压	I _{OL5}	0		300	mV
高电平输出电压	R _p <25 kΩ	90%		100%	VDD
低电平输入电压	下降	0		30%	VDD
高电平输入电压	上升	70%		100%	VDD
R _{pu} ⁶	VDD = 5V VIN = VSS	1	4.7	10	kΩ
输出电流	开		8		mA
	三态 (关)	10	20		μA
采样周期		2			S

¹ 在 25°C 和 1m/s 气流的条件下，达到一阶响应 63% 所需要的时间。

² 在挥发性有机混合物中数值可能会高一些。见说明书应用储存信息。

³ 此数值为 VDD = 5.0V 在温度为 25°C 时，2S/ 次，条件下的平均值。



图 2 : 25 °C时 DHT12 Relative humidity maximum error 图 3: Temperature sensor temperature Max errors

Six, electrical characteristics

Electrical characteristics, such as energy consumption, high and low level input and output voltage, depending on the power supply. Table 3 Details DHT12 The electrical characteristics, without marking, it means that the power supply voltage is 12V。

表 3 : DHT12 DC characteristics.

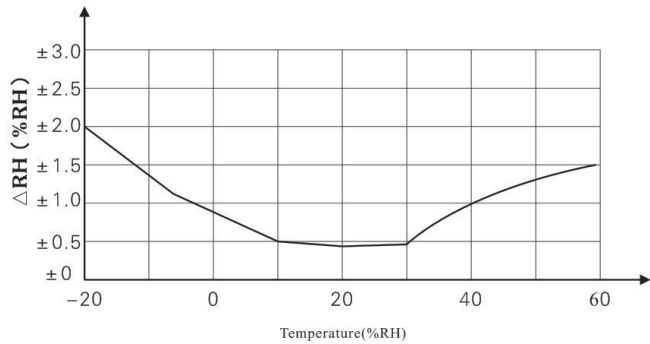
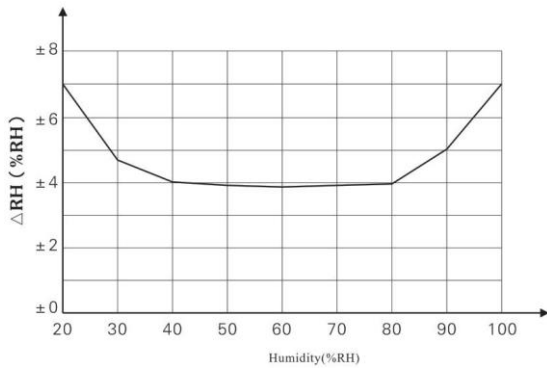
Seven, interface definition

7.1 DHT12 Pin assignments

表 4

PIN	The name	描述
1	VDD	Power supply (2.7V-5.5V)
2	SDA	Serial data, bi-directional
3	GND	地
4	SCL	Serial clock input(Single bus grounding)

: DHT12 Pin assignments



图 4 : DHT12Wiring diagram

7.2 Power supply pins (VDD GND)

DHT12 The supply voltage range 2.7V - 5.5V。

7.3 Serial clock input (SCL)

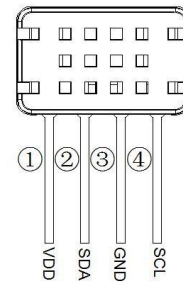
SCL Pins are used for selection of the means of communication and I²C Communication clock line. Dang SCL After power remained low, indicating that the user select a single bus

1

低电平输出电流。

2

表示上接电阻。

system communication, otherwise I²C Communication after the selected communication mode, in power during the sensor communication remains the same if you want to change, as a way, please power on again, and select communication according to operational requirements. When you select I²C Communication, SCL For the microprocessor DHT12 Communication between the synchronization.

7.4 Serial data (SDA)

SDA PIN for a three-State structure, used for reading and writing data. Specific communication timing, see the detailed description of the communications.

Eight I²C And single-bus communication protocol

DHT12 Serial interface, read sensor signals and power loss, do the optimization. Sensors with a single bus,

I²C Two way output, communication mode switch, easy to use. Bus to SCL Signal cable power levels to determine their bus communication mode: when power on SCL Remained low for a single bus communication mode when power on SCL To maintain a high level I²C Communication mode. Single main line single bus communication is fully compatible with the company's other products; I²C Communication in accordance with I²C Standard protocol address can be directly linked to I²C On the bus (bus allowed only one product), no additional wiring, operation is very simple. Read DHT12 The sensor, please in strict accordance with the two types of communication protocols and timing. Specific details see single bus communication protocol and I²C Communication protocol details.

8.1 DHT12 Sensor I²C Communication protocol

DHT12 Support I²C Way to communicate, in full accordance with I²C Standard protocol prepared, can be linked directly in I²C Bus sensor SDA PIN I²C Data bus, SCL 接 I²C Clock bus, customers need to both pin a 1KΩ~10KΩ Pull-up resistor. I²C Address for 0xB8(DEV SEL); I²C Communication rate cannot be higher than 400KHZ.

BYTE ADDR	R/W	Desc.	Note
0x00	R	Humidity integral digits	Relative humidity values
0x01	R	Humidity scale	

0x02	R	Temperature integer bit	The temperature value
0x03	R	Temperature scale	
0x04	R		Checksum

Data refer to the single bus data processing sample.

④ I²C Interface attributes

Must be in strict accordance with the following distribution specification, otherwise the sensor does not work.

Communication protocol:



图 13 I²C Communication

protocolReading time:

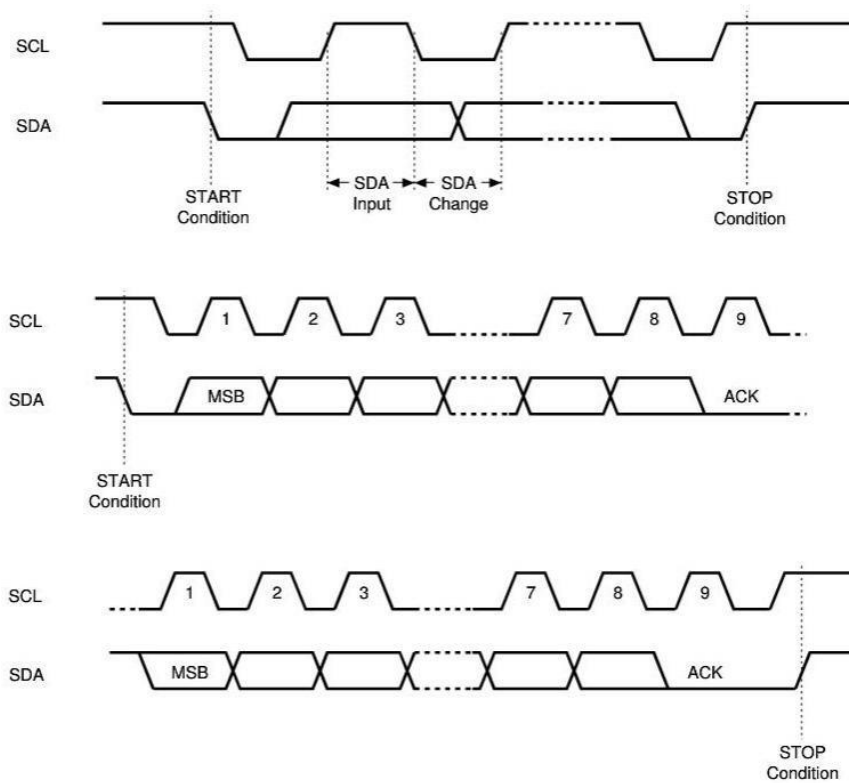

图 14 I²C Reading sequence

diagramsReference sequence:

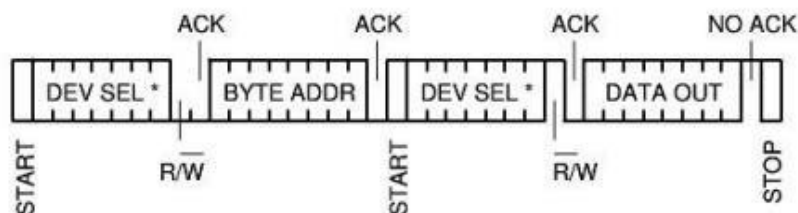

图 15 Reference sequence diagram Note: the actual test data

refer to the single bus-processing example.

8.3 Single bus communication (ONE-WIRE)

Single bus description

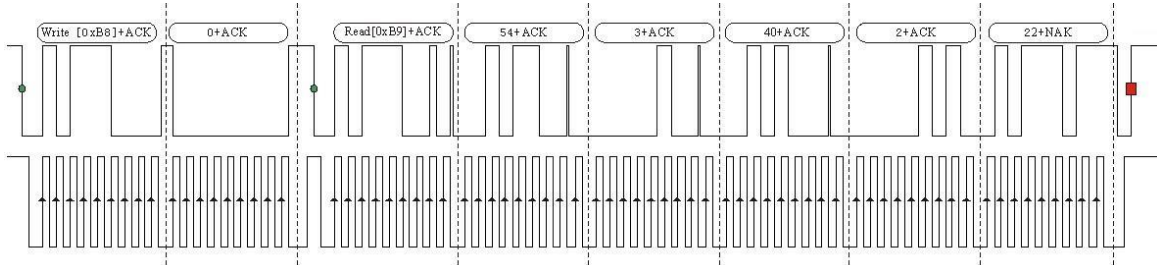
DHT12 A simplified single-bus communication. That only a single bus cable, system of data exchange, Control is done by a single bus communication. Devices (hosts) through a drain or a three-State port is connected to the data cable to allow device does not send data will be released when the bus, while letting the other device uses the bus; usually require add-ins a single bus around 4.7KΩ Pull-up resistor, so that when the bus is idle by default high State. Because they are the master-slave relationship, only when the host calls the sensor, the sensor responds, so host access must be strictly followed during single bus timing, timing disorder if will not be able to correctly read data of temperature and humidity.

Single bus transfer data definitions

SDA PIN for client hosts DHT12 Communication and synchronization between, by-wire data format, a transfer 40 Data high first. Specific communication Sequential as shown in the following figure, communication formats described in the following table.



图 16 Single bus communication timing description

Single bus data example:

The name	Single bus format definition
The starting signal	Host data bus (SDA) Down over time (18ms), Tells sensors to prepare data

The corresponding signal	Sensor data bus (SDA), Lower 80μs And higher 80μs In response to host the starting signal
Data format	Receives a host after the starting signal, sensors at once from the data bus (SDA) 40 Data, high
Humidity	Humidity high humidity integer data, humidity low humidity decimal data
Temperature	Temperature high temperature integer data, temperature low temperature decimal data, and low temperature Bit8 为 1 The negative temperature, otherwise positive temperature
Check digit	Check digit=Humidity high+Humidity is low+Temperature highs+Low temperature

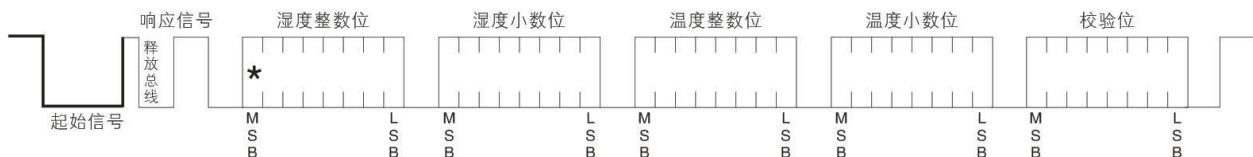
Example: receiving 40 Data for:

00111000 00001000 00011010 00000110 01100000

Humidity integral digits Humidity scale Temperature integer

bit Temperature scale Check digit

00111000+00001000+00011010+00000110=01100000(Check digit)

receive data properly:

Humidity:00111000 (Binary) =>56 (Decimal)00001000(Binary)=>8 (Decimal)

=>Humidity=56.8%RH

Temperature:00011010 (Binary) =>26 (Decimal)00000110(Binary)=>6 (Decimal)

=>Temperature= 26.6 degrees

Celsius Example two: received 40 Data for:

00111000 00001000 00011010 10000110 11100000

Humidity integral digits Humidity scale Temperature integer

bit Temperature scale Check digit

00111000+00001000+00011010+10000110=11100000(Check digit)

receive data properly:

Humidity:00111000 (Binary) =>56 (Decimal)00001000(Binary)=>8 (Decimal)

=>Humidity=56.8%RH

Temperature: temperature low 8Bit 为 1 It indicates sampling the temperature to minus-temperature

00011010 (Binary) =>26 (Decimal)

10000110 (Binary,Ignore 8Bit)=>6(Decimal)

=>Temperature=-26.6 degrees Celsius

◎Peripheral reading steps

Communication between the host and the sensor reads data by completing the following three steps.

Step one:

DHT12 After power up (start wait 2 Seconds to cross the unstable condition of the sensor) Tested environment temperature and humidity data, and record data, sensor automatic hibernation. DHT12 The data because of the pull-up resistor has remained high, at this time DHT12 的 SDA PIN is input, detect external signals.

Step two:

Hosting by SDA Data bus output low level and low level for at least 200ms Released by bus, DHT12 Detects a bus free, issue 80μs Low level immediately 80μs High level signal, as shown below:



图 17 Signal

Step three:

DHT12 After the response is sent immediately by the continuous serial data bus output 40 Data host under the bus level receive 40 Bit data.

Bit data "0" Format: 50μs Low level plus 26-28μs High level; data "1" Format: 50μs Low level plus 70μs High level; data "0", Bit data "1" Signal format shown in the following figure:

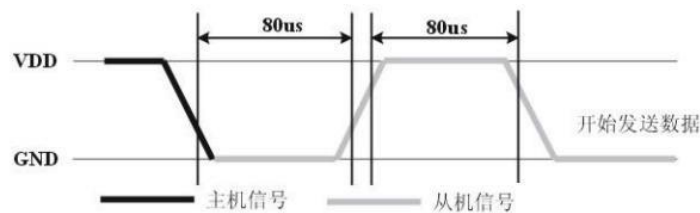

图 18 Bit data "1"和"0"Format signal

DHT12 The data bus output 40 Data, continue to output low level 50 μ s Free bus to enter State after. The same time DHT12 An environmental temperature and humidity data, and records the data automatically after entering hibernation.

⊙Typical circuit

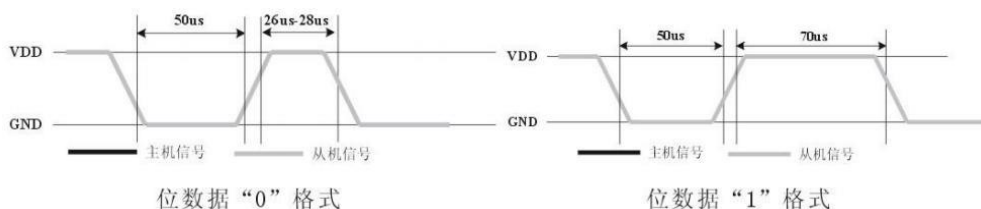

图 19 Typical circuit diagram

Microprocessor and DHT12 Connections on a typical application circuit shown in the figure, DATA After pulling on the microprocessor I/O Connected to the port.

1. Typical application circuit recommended cable length is shorter than the 20 Meter use 5.1K Pull-up resistor, is greater than 20 Meters lower the pullup resistor value according to actual situation.

2. Each numerical readout of temperature and humidity is the result of the last measurement, to get real-time data, need to read twice in a row, but not recommended to read several times in succession, each read sensor spacing is greater than 2 Seconds to obtain accurate data.

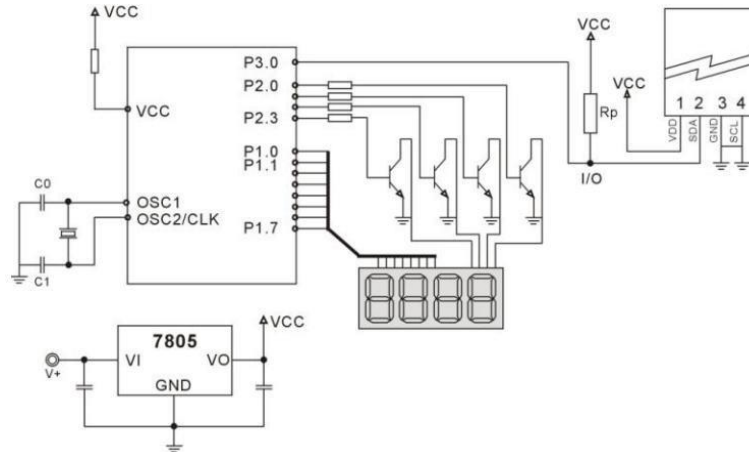
⊙Peripheral read flow charts

DHT12 Sensors read the single bus flow chart shown in the following figure, while the company also provides a C51 Reading the code to download customer, please visit the company's website (WWW.AOSONG.COM) To download, no reference code here.

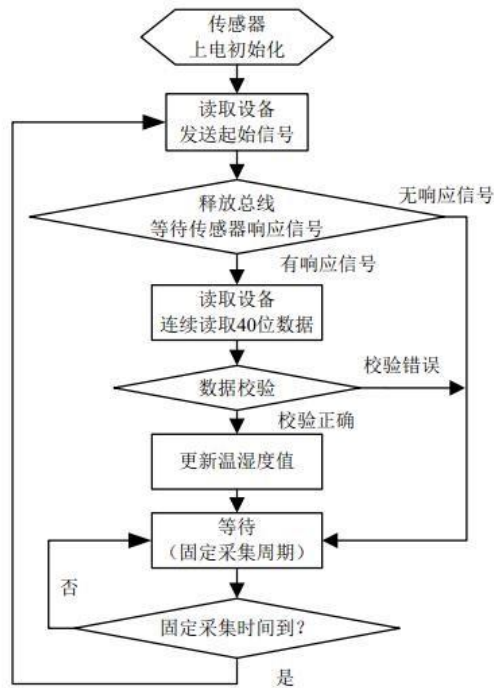

Nine, information

1、 Working and storage conditions

Beyond the scope of the proposed work could lead to up to 3%RH Temporary drift of signal. After his return to work, and sensor calibration status slowly recovered. To speed up the recovery process, see "Recovery processing" 。 In non-working condition used for a long time may accelerate the aging process.

Avoid long in the component condensation and dry environment, as well as the environment.

- A、 Salt spray
- B、 Acidic or oxidizing gases, such as sulphur dioxide, hydrochloric acid
- C、 Volatile organic solvents recommend gas storage environment

Temperature: 10~40°C Humidity: 60%RH The following

2、 Effects of exposure to chemical substances in

Induction of resistance humidity sensor layer affected by interference of chemical vapors, chemical diffusion in sensitive layer may lead to measuring drift and sensitivity. In a pure environment, polluting substances slowly released. The recovery process described below will

accelerate this process. High levels of chemical pollution can cause damage to the sensor completely.

3、 Influence of temperature

The relative humidity of the gas, and to a large extent depends on the temperature. So when you measure humidity, should as far as possible ensure that humidity sensor at the same temperature. Electronics components share a Board with the heat, should as far as possible away from the sensor in the installation of electronic components, and installed directly below the heat source while maintaining the good ventilation of the shell. To reduce heat conduction, sensors and other parts of the printed circuit board copper plating Layer should be as minimal as possible, and to leave a gap between the two.

4、 Light effects

Prolonged exposure to sunlight or strong ultraviolet radiation will decrease performance.

5、 Recovery processing

Placed in extreme working conditions or chemical vapor sensors with the following handlers, can be brought back to the school on time. In 50 °C 和 < 10%RH Humidity conditions 2 Hours (drying); 20-30 c 和 > 70%RH Humidity conditions 5 Hours or more.

6、 Wiring considerations

Signal quality of wire affect the communication distance and traffic quality, recommended use high quality shielded cables.

7、 Manual welding welding information at the highest 300 cTemperature conditions of contact time shall be less than 5 Second.

Ten, license agreement

Without the prior written permission of the copyright holder, and shall not in any form or by any means, whether electronic or mechanical (including photocopying), make copies of any part of this manual, shall not be communicated to third parties. Contents of this instruction manual is subject to change without prior notice.

Ozon in Guangzhou Electronic Ltd and any third party ownership of software, users must sign a contract or use license before using the software.

Third, warnings and personal injury

Do not apply this product to the safety protection device or emergency stop devices, as well as the failure of the product could result in personal injury in any of the other applications. Shall not use this product unless there is a special purpose or use license. The installation, handling, use or maintenance of the product to refer to product data sheet and application guide. If it is notTo comply with this recommendation, may result in death or serious bodily injury, the company will not be liable for the resulting personal injuries and deaths of all compensation and exemption from the managers and employees of the company and the subsidiary agents, distributors, any claims that may arise, including: all costs, damages, attorney fees, and so on.

12, quality assurance

The company direct purchasers of its products for a period of 12 A month(A year)Quality assurance(Since the date of delivery)。 Company published the technical specifications of the

- ① product data sheet shall prevail. If within the warranty period, the products are quality
- ② defects are, the company will provide free repair or replacement. Users must meet the
- ③ following criteria: the product defect found 14 Days written notice to the company; the

product should be sent back to the company by the buyers paid; the product is within the warranty period.

The company only for those applications in compliance with the product specifications of the occasion and produce defective products. Company products used in those special applications do not make any warranties, guarantees or written statements. Company about the reliability of its products used in products or circuits are not making any promises.